

De Brauwweg 24-30
3125 AE Schiedam



Tel.: +31(0)10 4379089

Fax : +31(0)10 4154966

Mob: +31(0)6 51203449

E-mail: info@orbin.nl

Internet: www.orbin.nl

- Opgericht in 2001
 - Dienstverlening in VG MK voor de Industrie en Publieke Sector
 - Geïntegreerde Proactieve Praktische Aanpak
 - Consultancy & Detachering i.s.m. Usg innovativ
-

- QA Systeem Ontwikkeling & Implementatie
 - Milieu Effect Rapportages & Studies
 - Veiligheid studies & Risico Analyses
 - RBI/RCM Asset Management
 - RAM/LCC analyses
 - Operationele Ondersteuning
-

- **Systeem Ontwikkeling (ISO 9001, 14001)**
 - **Systeem Opwaardering**
 - **Implementatie & Auditing**
-

NPP 5 Man-hour and cost control

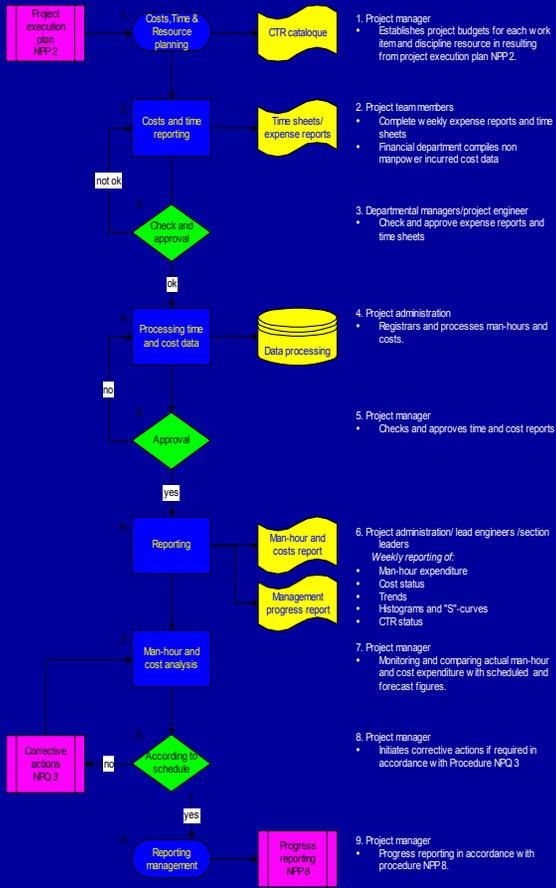

Nevesbu ISO 9001

VandenBorre ISO 9001/EN 13980

Westinghouse ISO 9001/EN 13980

- Management & Coördinatie
 - Technische beschrijving alternatieven
 - Milieu Effect Rapportages
 - Quantitatieve Risico Analyse
 - Deelstudies
-

- MER Gas Winning in het Q4 blok van het NCP Clyde Petroleum
 - Lozing oliehoudende mengsels van mijnbouwinstallaties Min EZ
 - Olie en Gas leiding door de Waddenzee
NAM
-

- Geluids rapport uitbreiding gas terminal den Helder Conoco
 - Geluid en vibratie metingen en berekeningen gas productie platform Wintershall
 - Geluid en vibratie metingen en berekeningen olie productie platform Chevron
 - CO₂/NO₂/CH₄ dispersie analyse Horizon platform Chevron
-



ORBITAL Veiligheid studies

HSEQ Consultants

- HSE Plannen
 - Quantitative Risico Analyses (Soveso/BEVI)
 - Safety cases
 - Aanvaring/aanvlieg analyses
 - Explosie analyses
 - Risk Based Inspection
 - Reliability Centered Maintenance
 - ATEX 95 Beoordeling
 - ATEX 137 Implementatie & Opleidingen
-

- HSE Plan offshore windmolen transformator platform HBG
 - PVP station Middelharnis ENECO energie
 - Explosie bestendige controle kamers en werkplaatsen BASF, Shell en BP
 - Risico Register update Provincie Zeeland
 - BEVI risico contour Sloegebied Prov. Zeeland
 - IPO-9 Stand der Veiligheidstechniek
 - Inherente Veiligheid Prov. Zeeland
 - RELEVANT Kennistafel Techniek
-

- QRA's offshore pijpleidingen NOGEPA
 - Zeeleiding natuurlijke ingraaf analyses
 - Risico analyse transport mobiel platform Clyde
 - Brand belastingen en beveiliging SBM Gusto MSC, Monsanto
 - Scheepsaanvaring analyses NAM, Chevron
-

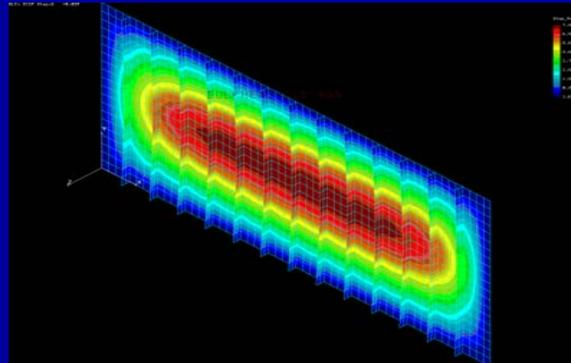
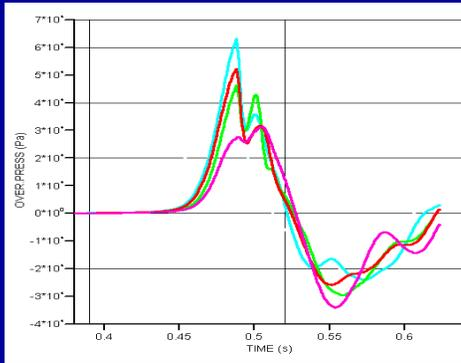
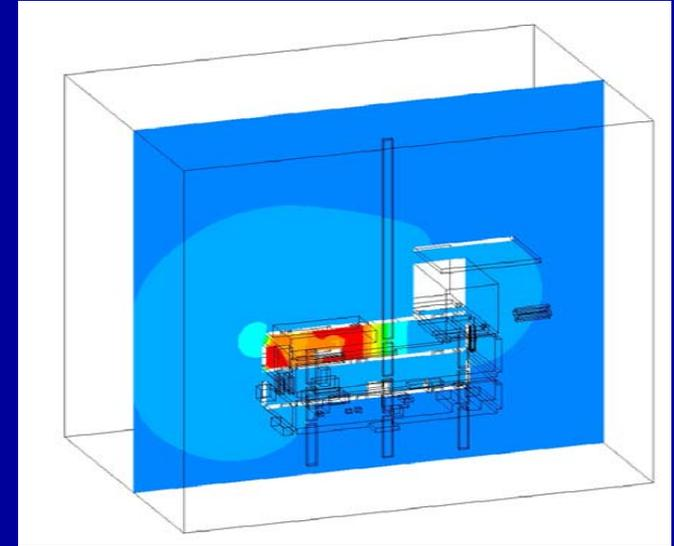
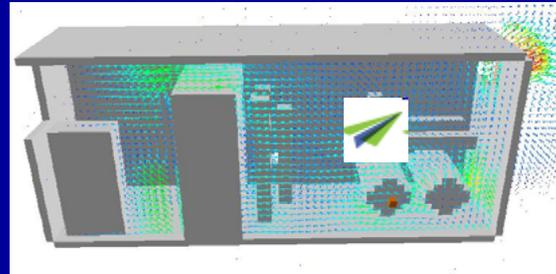
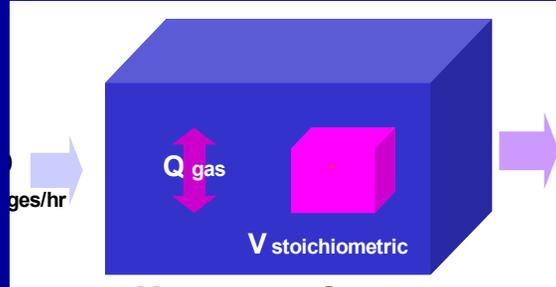

Safety	Business (€)	Environment	Risk Rating	Occurrence				
				Once in 1000 Years	Once in 100 Years	Once in 10 Years	Once per Year	> 10 per Year
3 or more fatalities	50m-100m	> 30m ³	E	M	H	H	H	H
1 or 2 fatalities	1m-50m	100ltr - 30m ³	D	M	M	H	H	H
1 or more DAFWC	100k-1m	10 ltr - 100ltr	C	L	M	M	H	H
1 or more recordable	10k-100k	1ltr - 10ltr	B	L	L	M	M	H
First Aid	<10k	< 1ltr	A	L	L	L	M	M

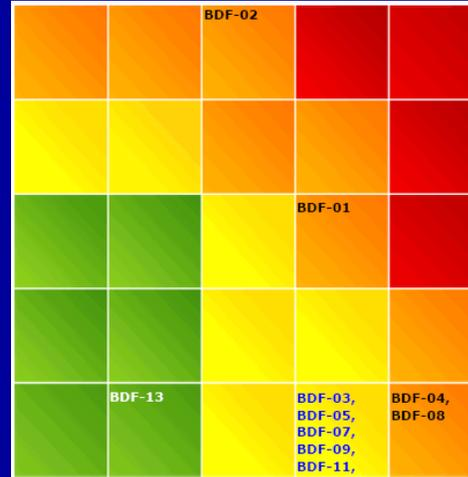

ORBITAL ATEX 95 Beoordeling

HSEQ Consultants

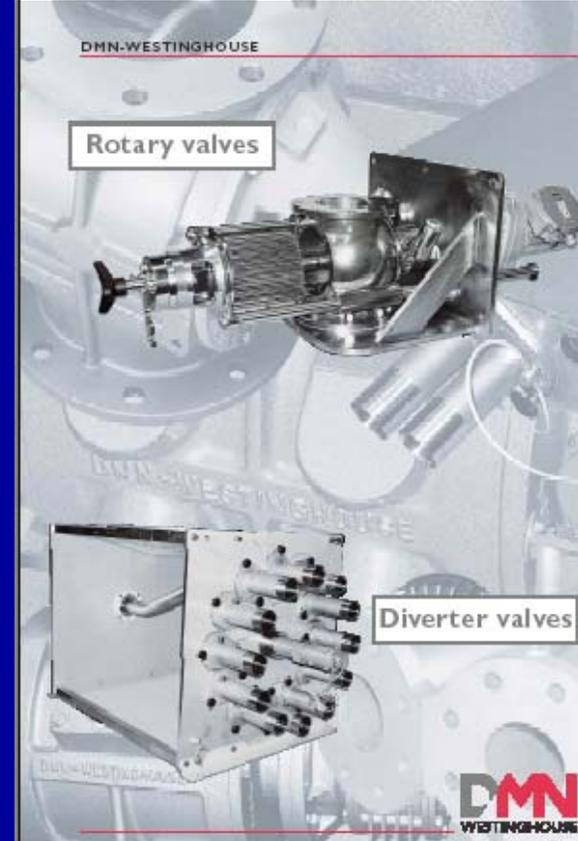

ORBITAL ATEX 137 Implementatie & Training

HSEQ Consultants



- Project management
 - Constructie management
 - Change management
 - Contract management
 - Inkoop
 - Planning & cost control
 - HSE
 - QA
-

- Project manager NAM/Clyde/Conoco/Cirrus
 - Construction manager Gaz de France
 - Project Engineer KEMA automation project
 - HSE Engineer Nuon Buchenum
 - RBI/RCM/LCC Manager Chevron
 - Engineering/Change Manager Allseas
-